



BARICHELO
ARCHITECTURAL

TEAM OF FIRMS

Loves  your Architectural Project

Case History

WE ARE WORLDWIDE

Our way of being Expert,
Professional, Punctual, Professional,
Up-Dated, brought us everywear

- > 01 . Hamad International Airport . Doha, Qatar
- > 02 . Midfield Terminal Building . Abu Dhabi, EAU
- > 03 . Mediaset Offices . Milan, Italy
- > 04 . Trust Building Complex . Bab Ezzouar Algeri, Alger
- > 05 . Fondaco dei Tedeschi . Venice, Italy
- > 06 . Azerbaijan Pavilion Expo 2015 . Milan, Italy
- > 07 . North Gate Mall . Doha, Qatar
- > 08 . Futur Palais De Justice . Paris, France
- > 09 . ONE CROWN PLACE . London, UK
- > 10 . Uber Headquarter . San Francisco, USA
- > 11 . MiCo Milan Convention Centre . Milan, Italy
- > 12 . San Raffaele Hospital . Milan, Italy
- > 13 . People Mover . Doha, Qatar
- > 14 . Watermark LLC27-19 . New York, USA
- > 15 . Torre Isozaki, Milano City Life . Milan, Italy
- > 16 . One Bishopgate Plaza London . London, UK
- > 17 . 11-15 Grosvenor Crescent . London, UK
- > 18 . Capital Market Authority . Riyadh, KSA





Hamad International Airport

- Doha, Qatar



Hamad International Airport

Doha, Qatar



Budget



Size



Duration



What we did

balaustrades, security screens, waterfall structure, lay-light, almost everything in stainless steel in the interiors



Architects

HOK - San Francisco

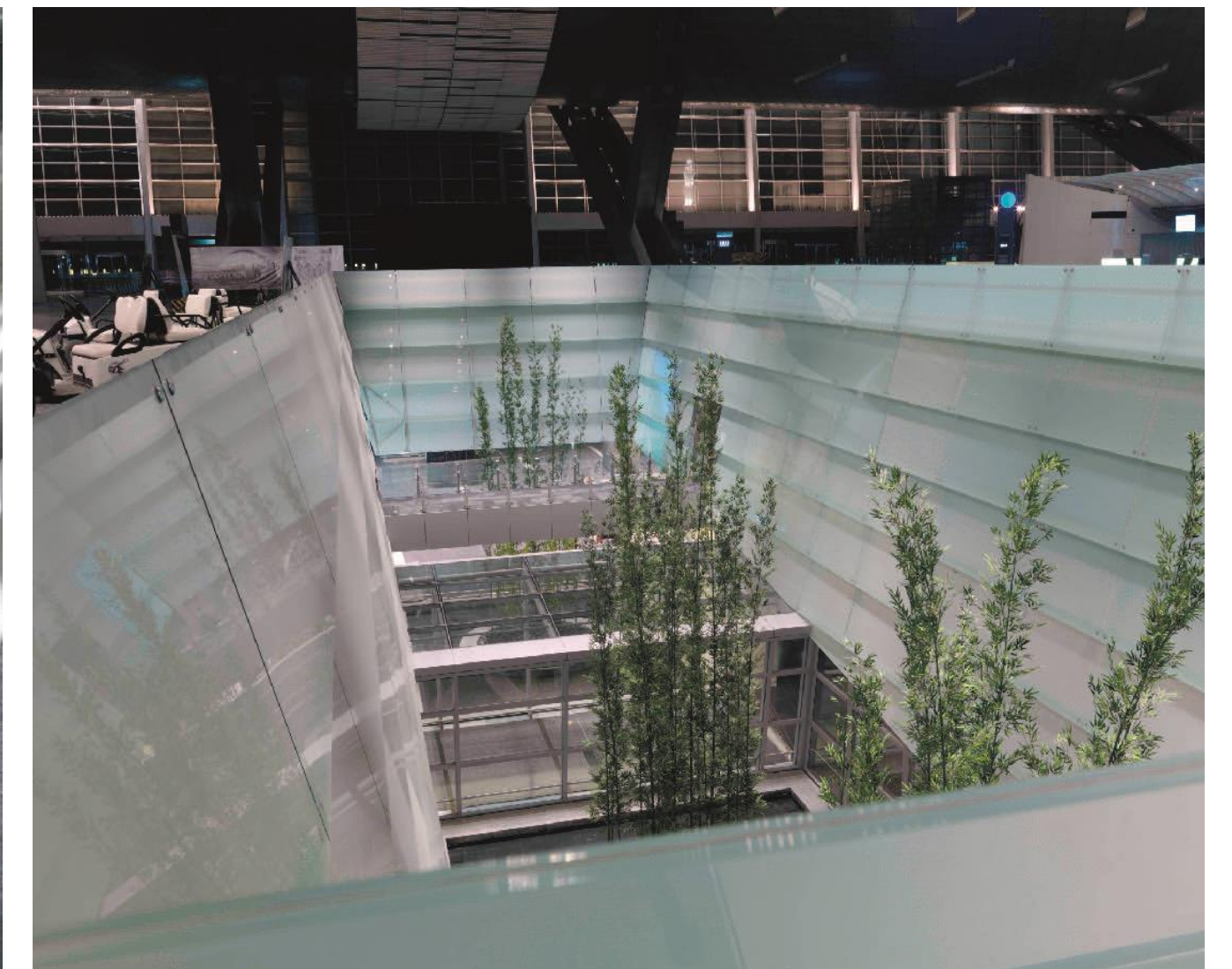
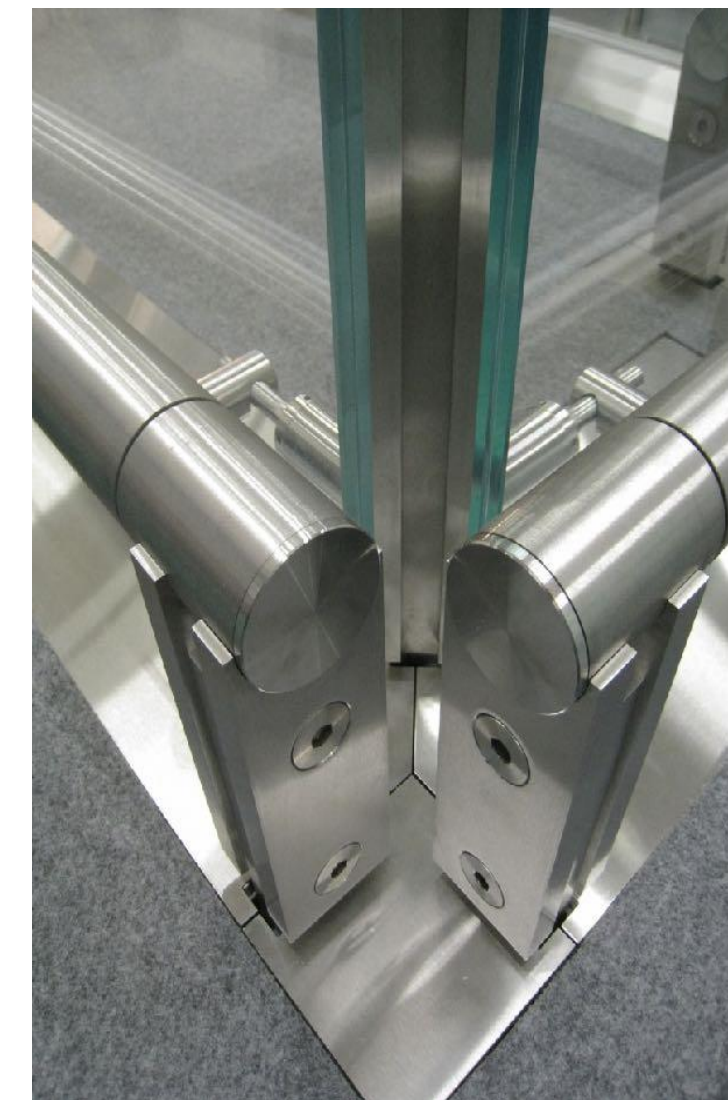
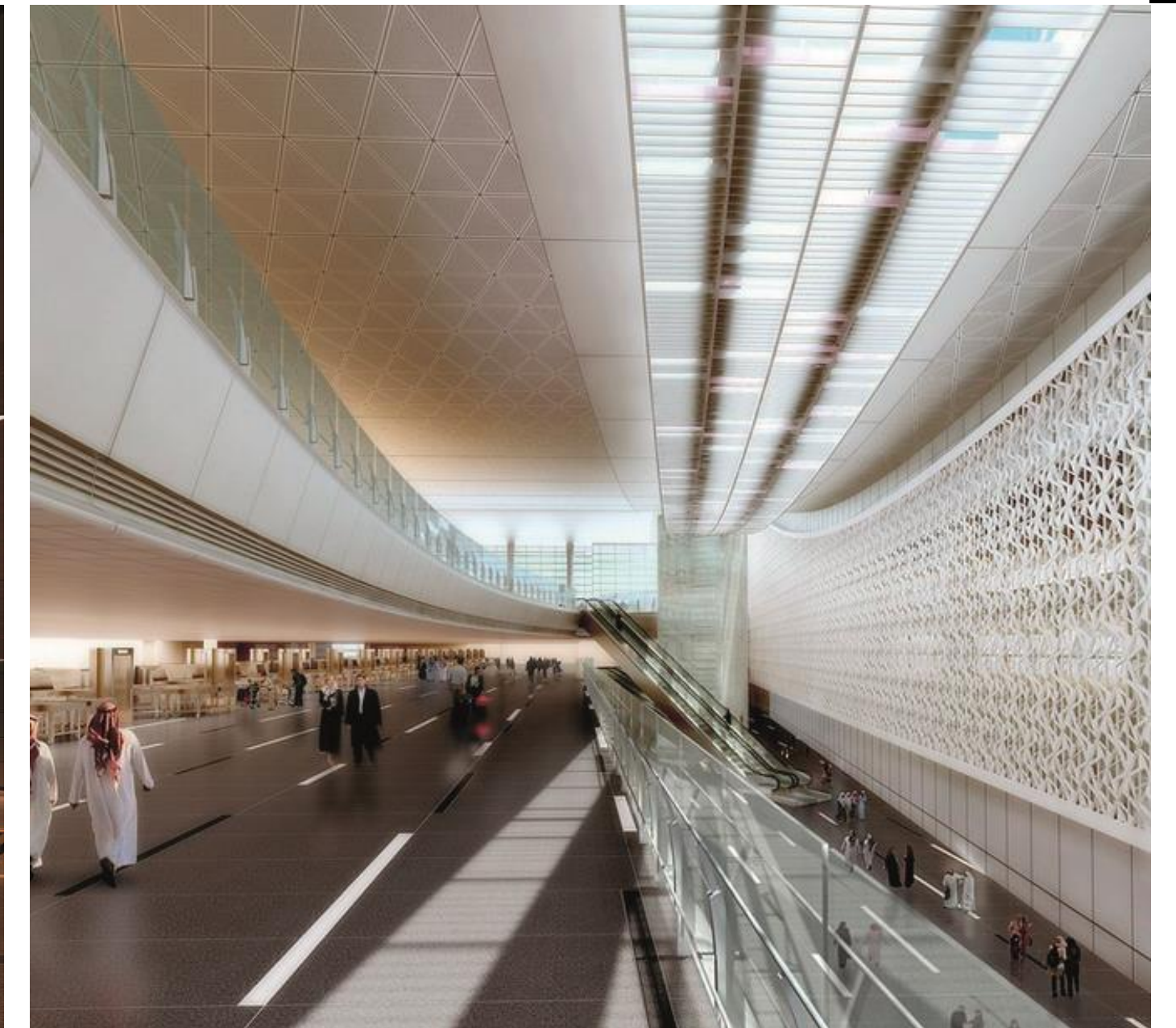
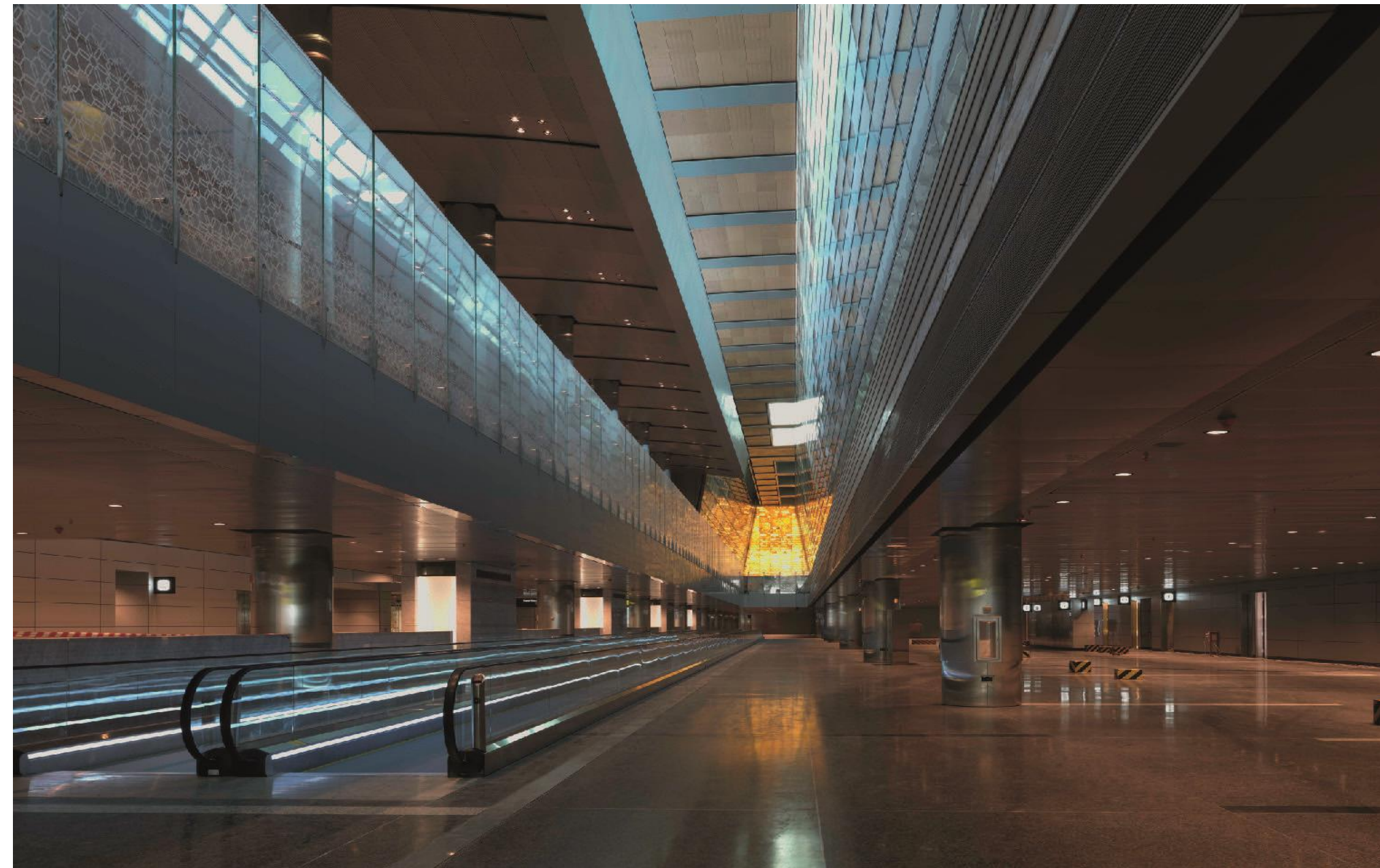

BARICHELLO
ARCHITECTURAL



Midfield Terminal Building

- Abu Dhabi, EAU



Midfield Terminal Building

Abu Dhabi, EAU



Budget



Size



Timing



What we did
Production of bespoke
components in AISI 316 SS for
the Sana Al-Nour Ecological
Cable System



Architects
Carpenter Lowings

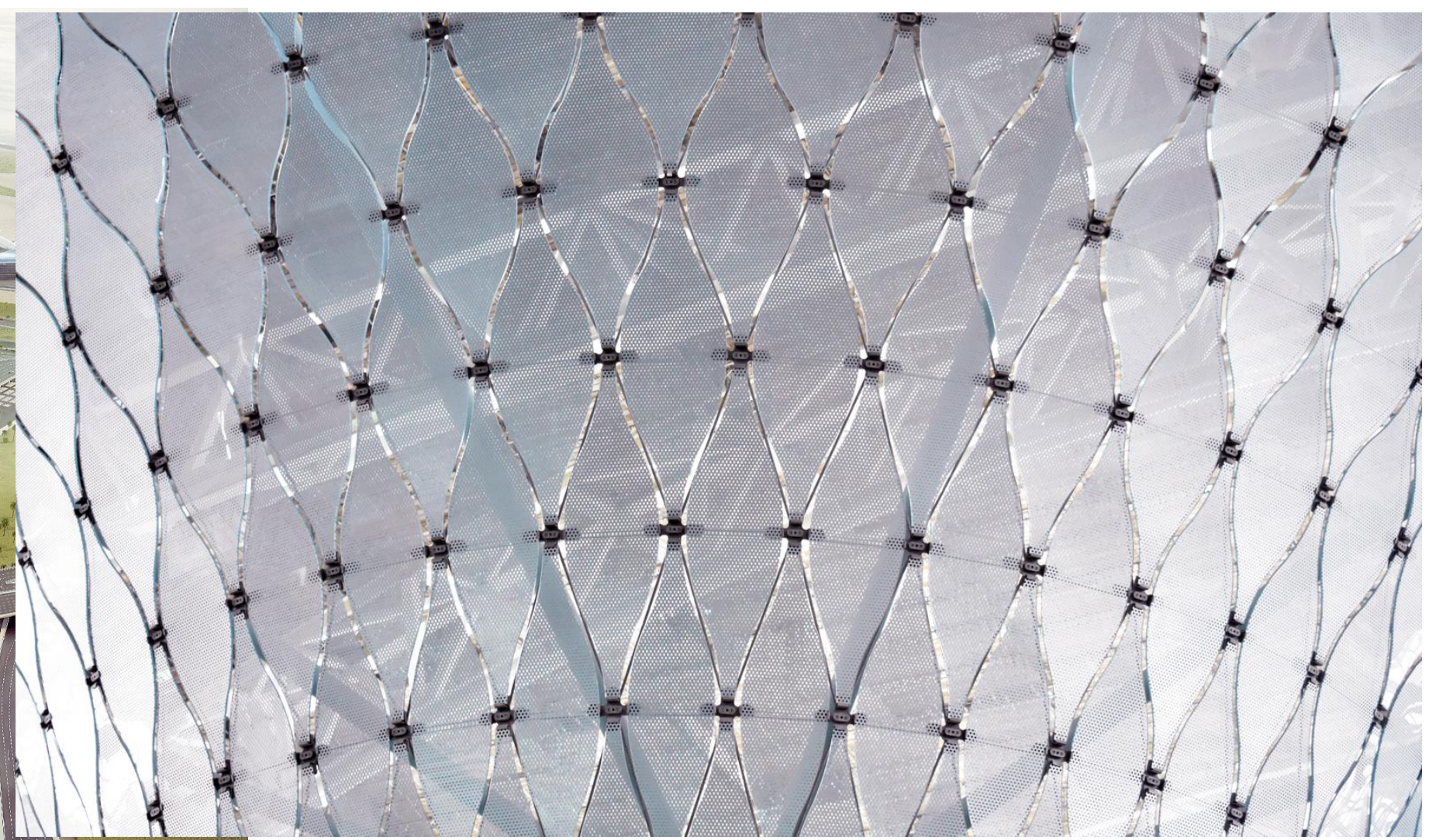
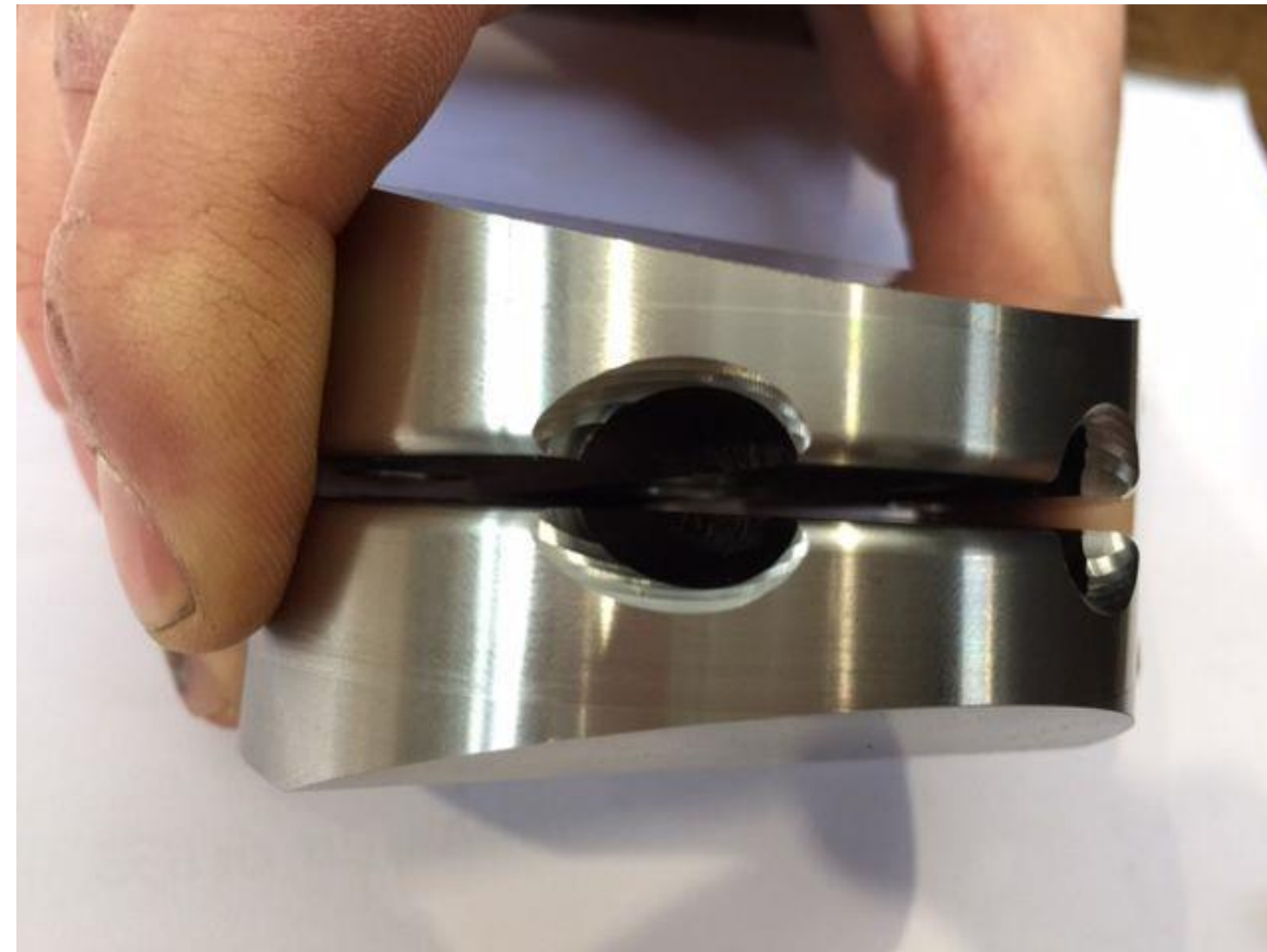



Mediaset Offices

- Milan, Italy





Mediaset Offices

Milan, Italy



Budget



Size



Duration



What we did
Structure project
Structure production
Glass holding system for
second skin production
Facade in stallation

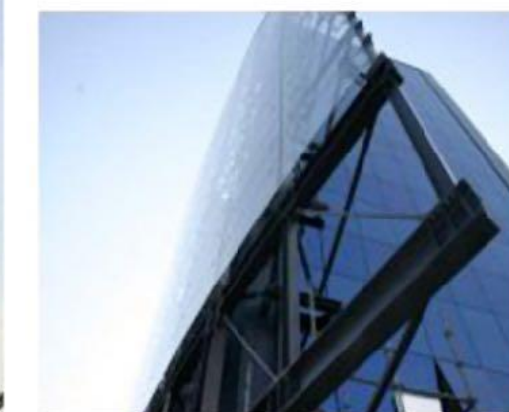

Sancta Maggiore Morumbi

São Paulo, Brasil



Sancta Maggiore Hospital



Budget



Size

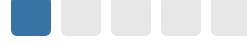

Duration

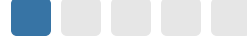

What we did

- Glass & Stainless Steel modeling of ground floor
- Construction drawings
- Production of SS parts



MOL CAMPUS

Budapest, Hungary



MOL Group Campus Head Quarter

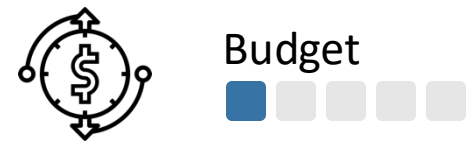

What we did
Production of hot deep
galvanized steel brackets



Architects
Foster & Partners



Trust Building Complex

- Bab Ezzouar Algeri, Alger

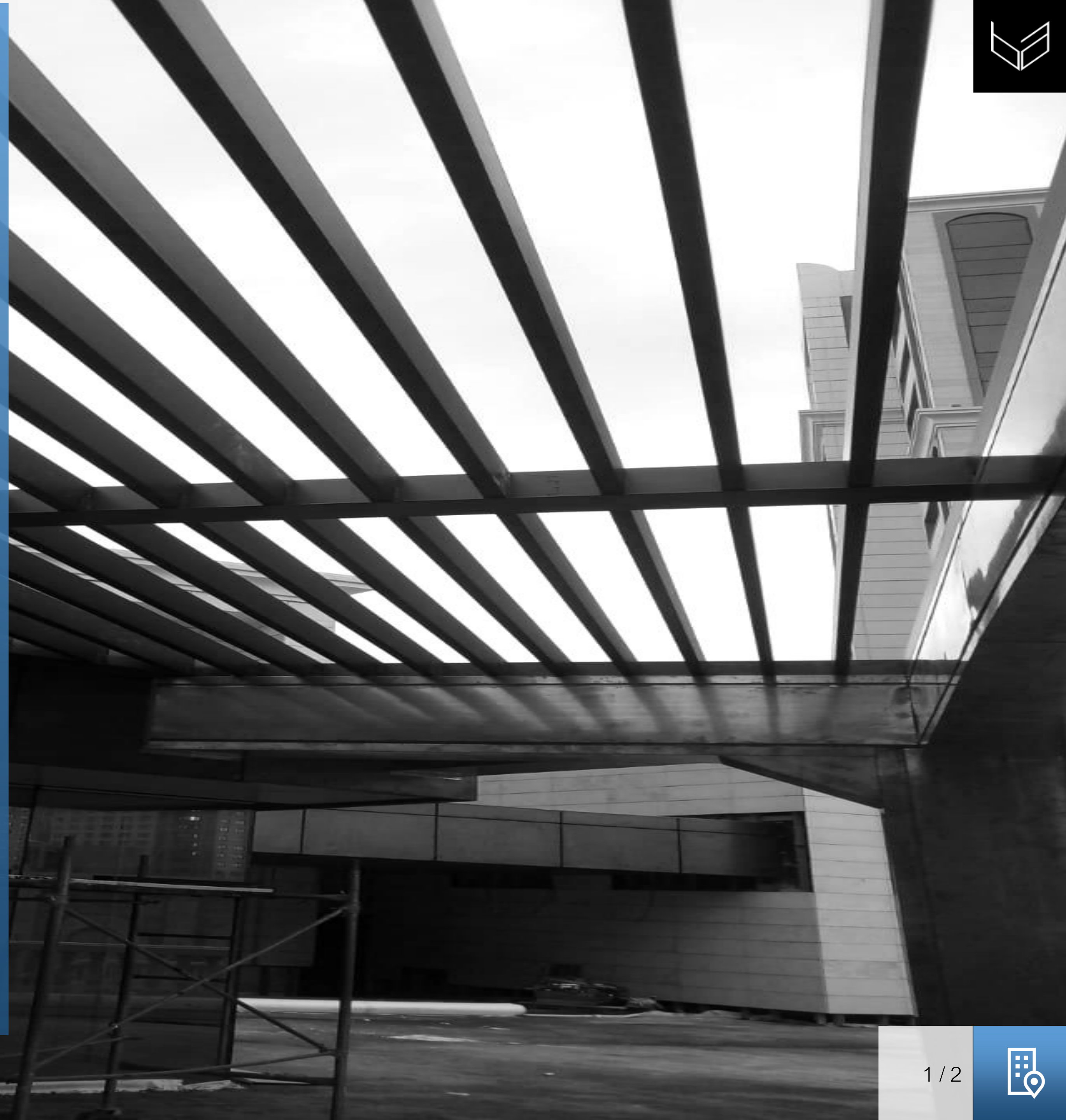

Trust Building Complex

Bab Ezzouar Algeri, Alger



Budget



Size



Duration



What we did

Project, production, installation, certification of J block, H block, B block structures, of various domes, shading systems, glass facades, copper roofing and carters, inslulation systems, interior musharabia walls



Consultants

Mood, Projacs

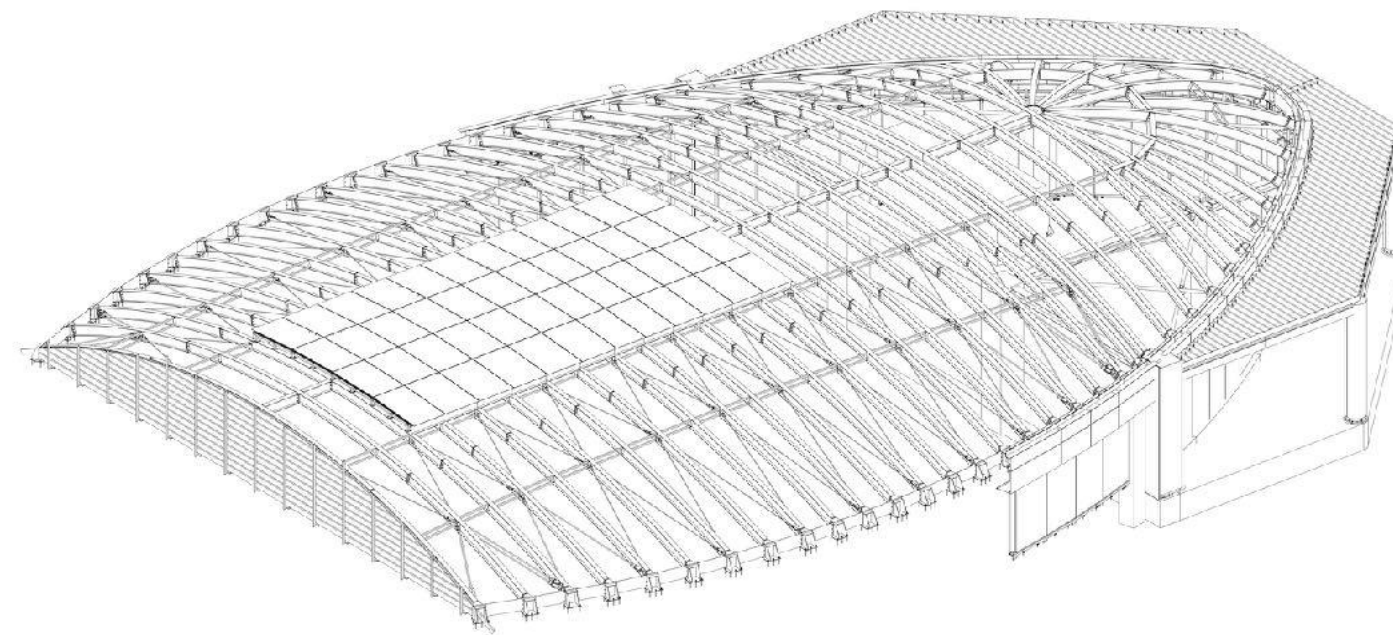
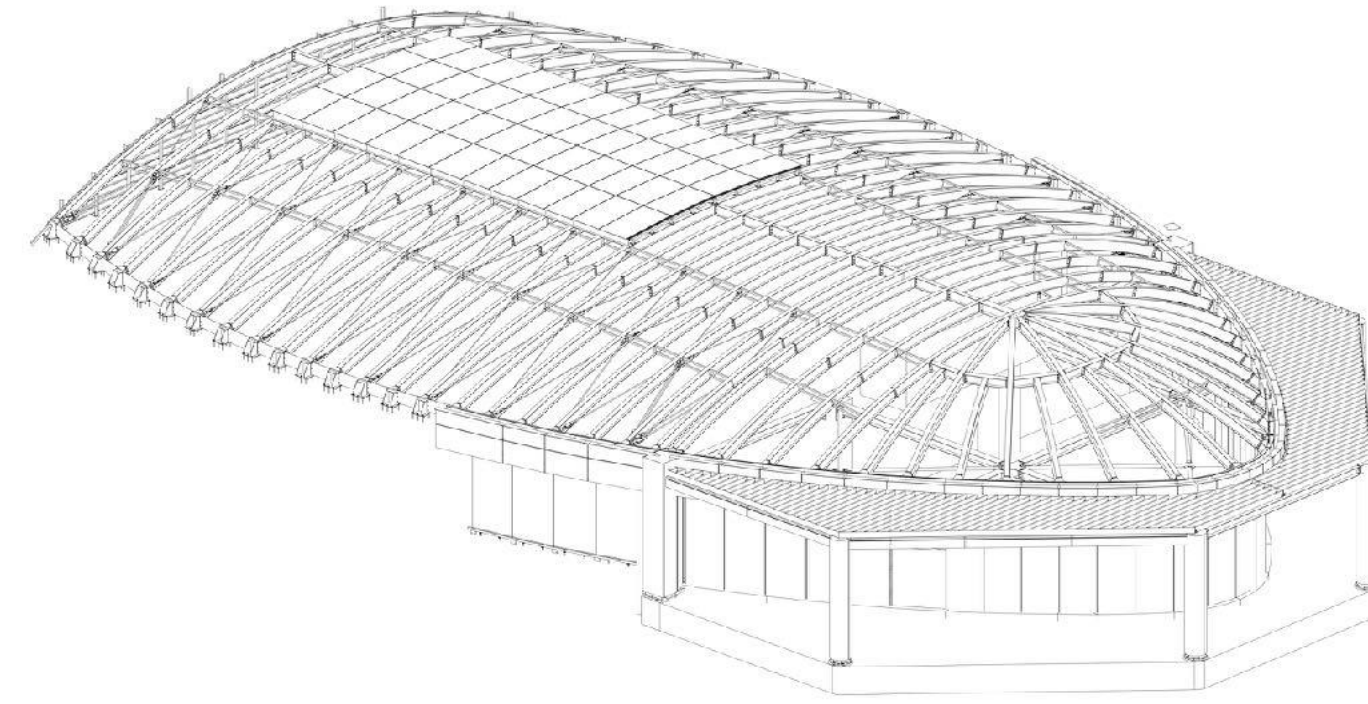

Trust Building Complex

Bab Ezzouar Algeri, Alger

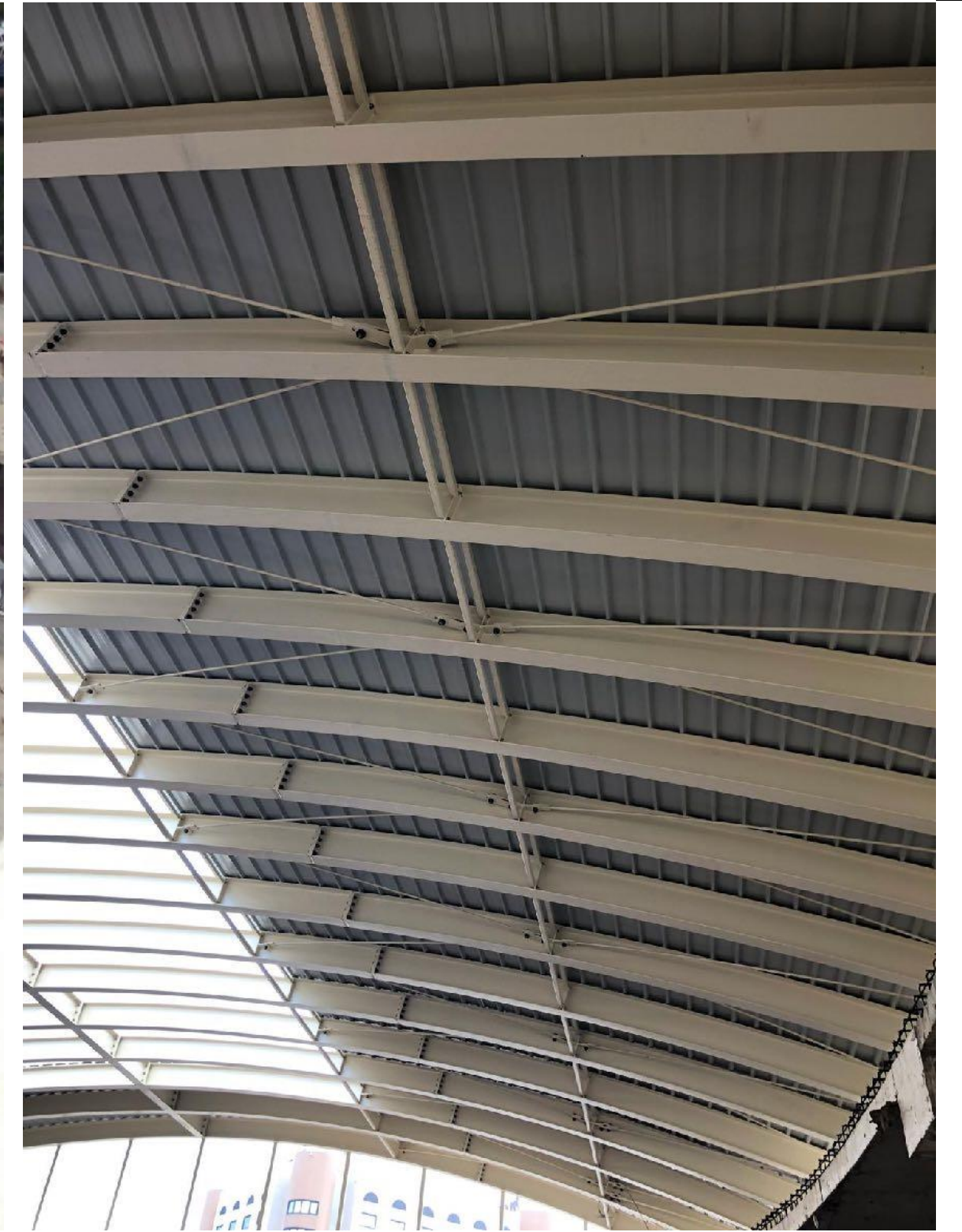

Trust Building Complex

Bab Ezzouar Algeri, Alger

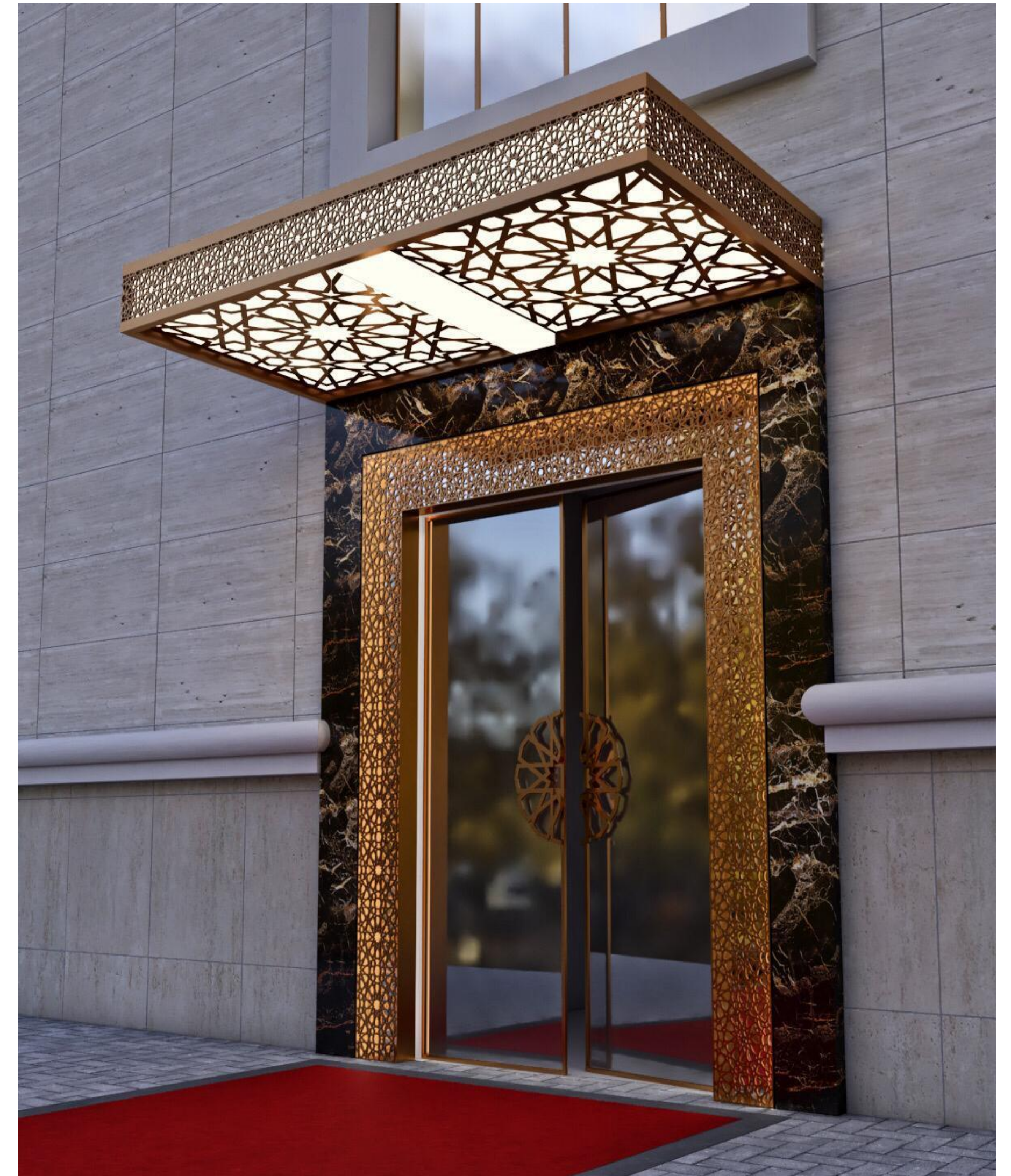
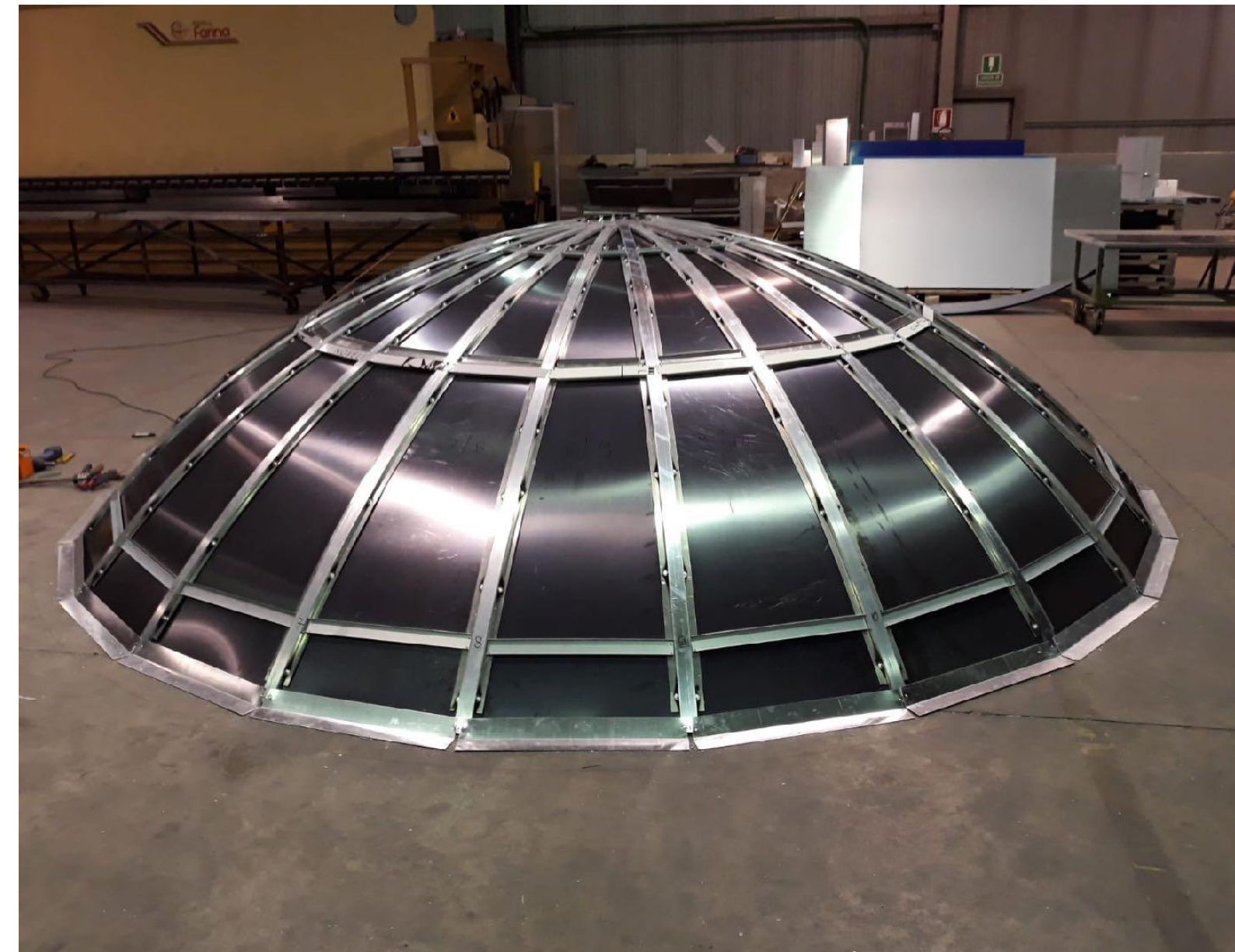



Fondaco dei Tedeschi

- Venice, Italy



Fondaco dei Tedeschi

Venice, Italy



Budget



Size



Duration



What we did

Project, production, installation of central skylight



Architects

OMA - Rotterdam

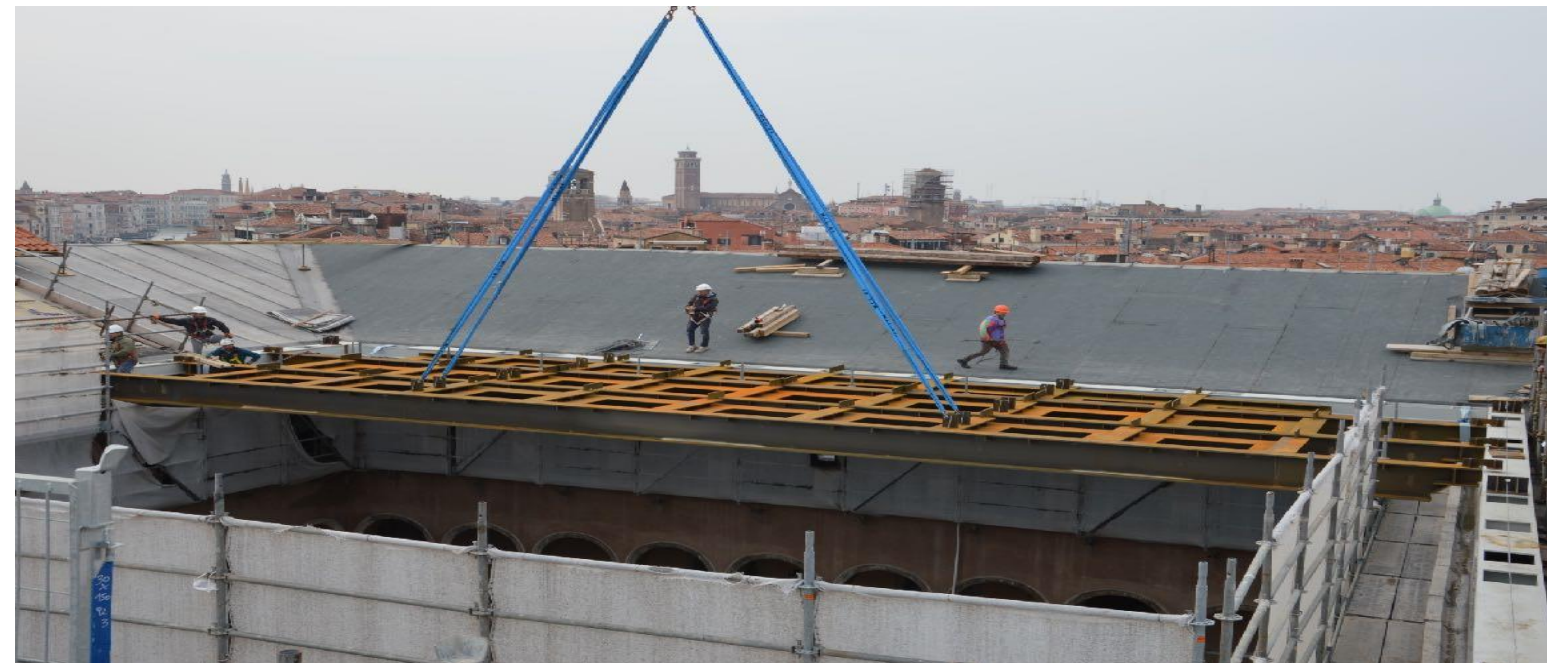
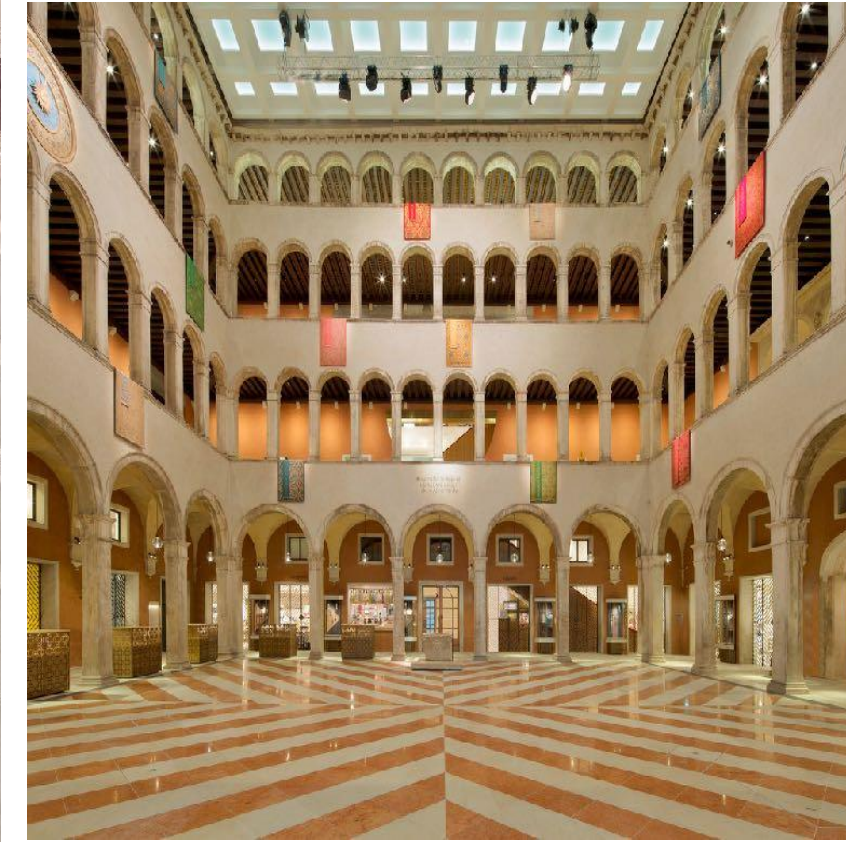
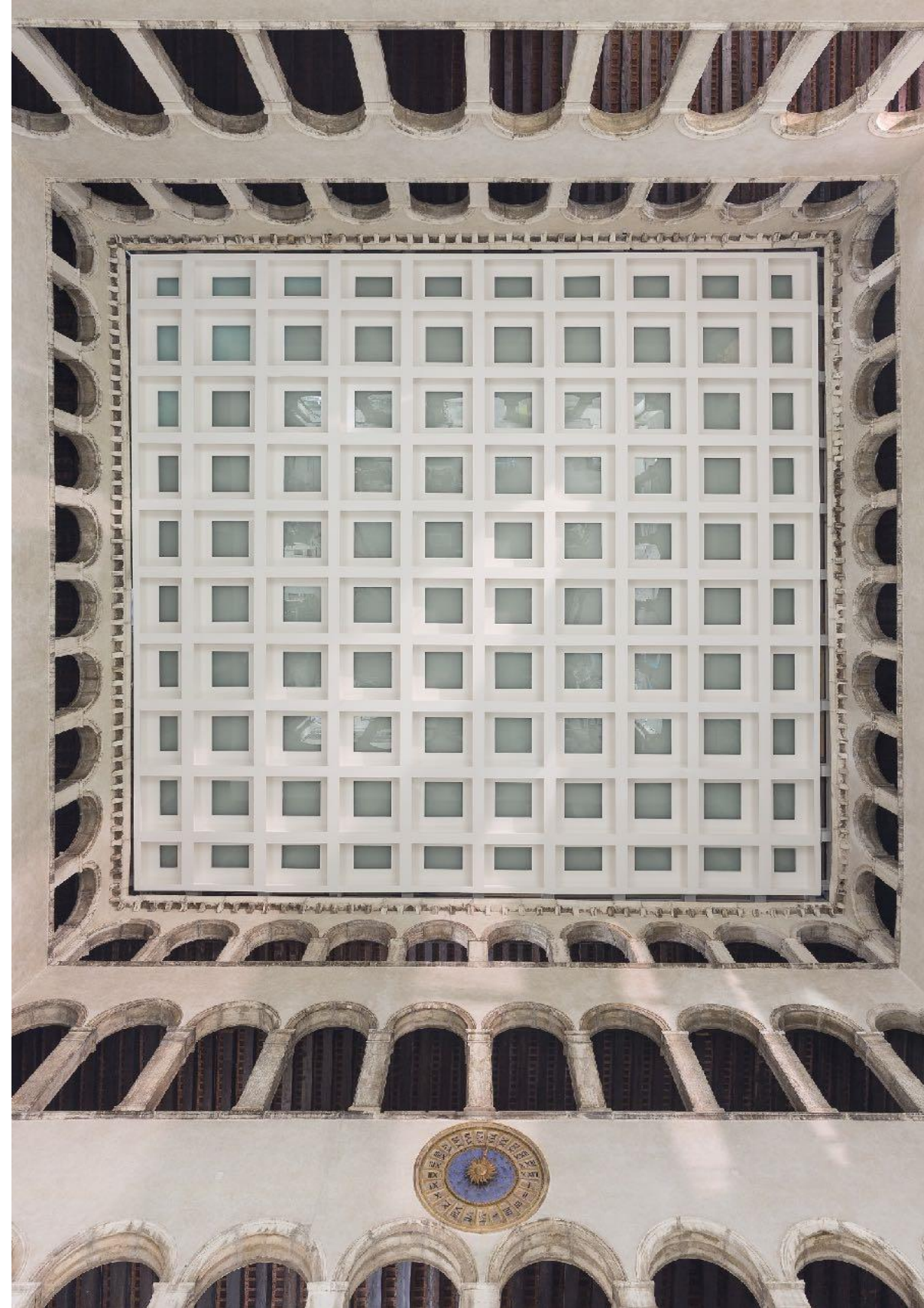

BARICHELLO
ARCHITECTURAL



Azerbaijan Pavilion Expo 2015

- Milan, Italy



Azerbaijan Pavilion Expo 2015

Milan, Italy



Budget



Dimension



Time



What we did

Project, production, installation of
glass spherical structure



Architects

Arassociati - Milan



BARICHELLO
ARCHITECTURAL



North Gate Mall

- Doha, Qatar



Doha North Gate Mall

Doha, Qatar



Budget



Dimension



Time



What we did

Crystal garden stainless steel brackets for glass facade. Outstanding measure



Architects

Callison - Seattle

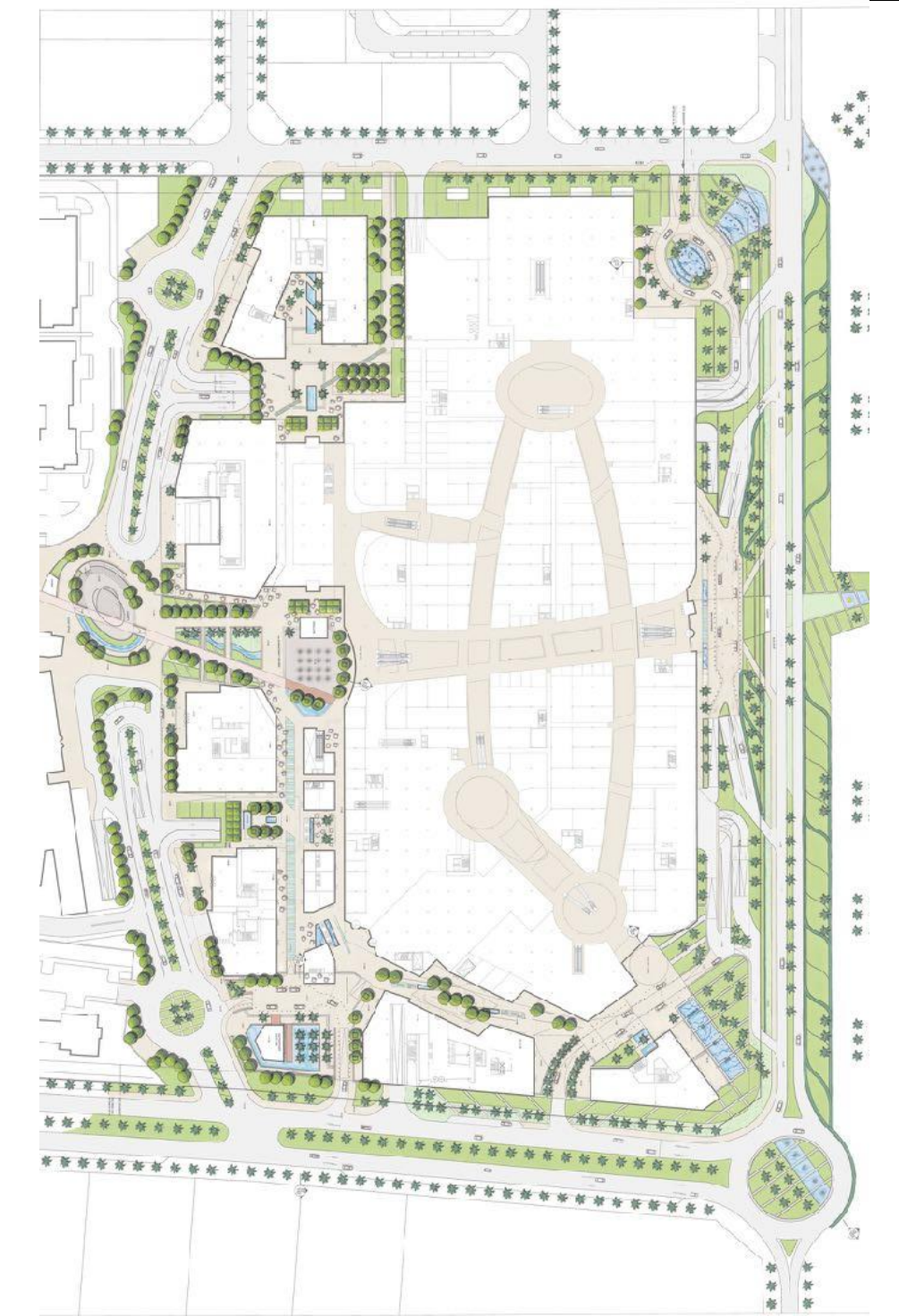

BARICHELLO
ARCHITECTURAL



GES - 2

- Moscow, Russia



GES - 2

Moscow, Russia



Budget



Size



Time



Interventi

Production drawings, stainless steel components for interior, aluminum carters, steel metalwork



Architects

Renzo Piano - Genova

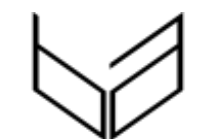
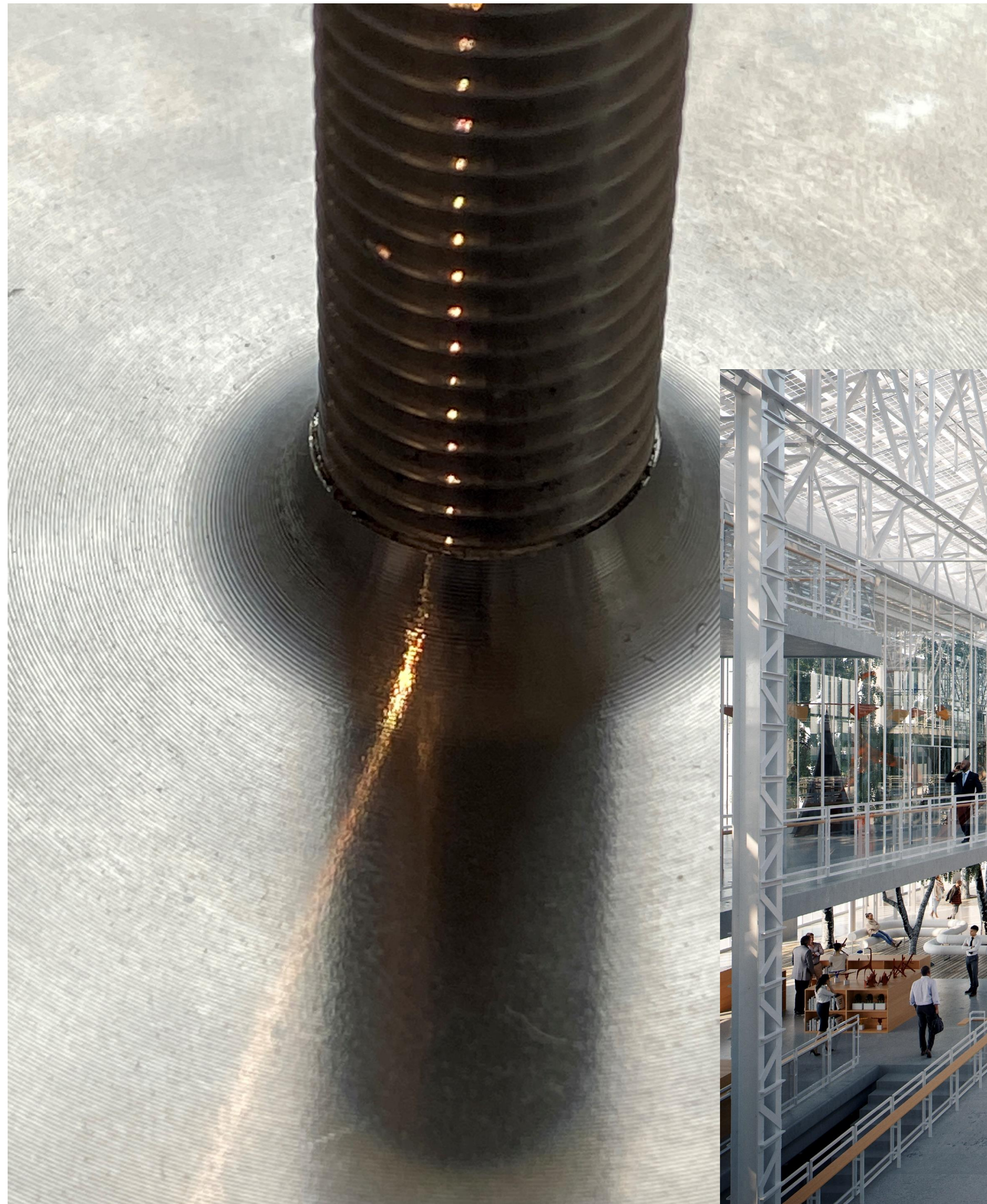

BARICHELLO
ARCHITECTURAL





One Crown Place

- London, UK



One Crown Place

London, UK



Budget



Dimension



Time



Project Detail

Metal components for facades, stainless steel carters, aluminum components



Architects

KPF Kohn Pendersen Fox - New York

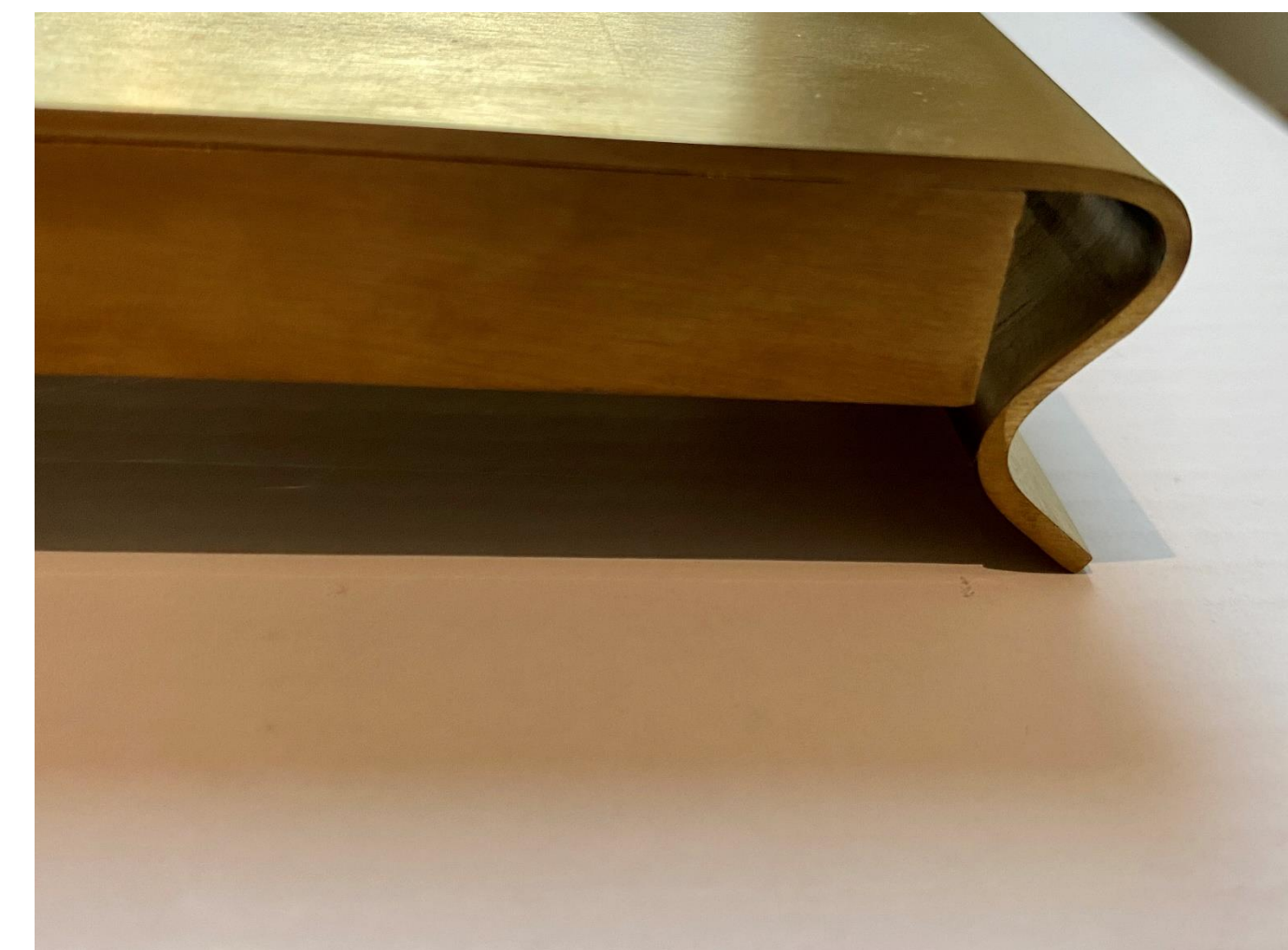

BARICHELLO
ARCHITECTURAL



Uber Headquarter

- San Francisco, USA



Uber Headquarter

San Francisco, USA



Budget



Size



Time



Project Detail

Stainless steel components



Architects

SHOP - New York

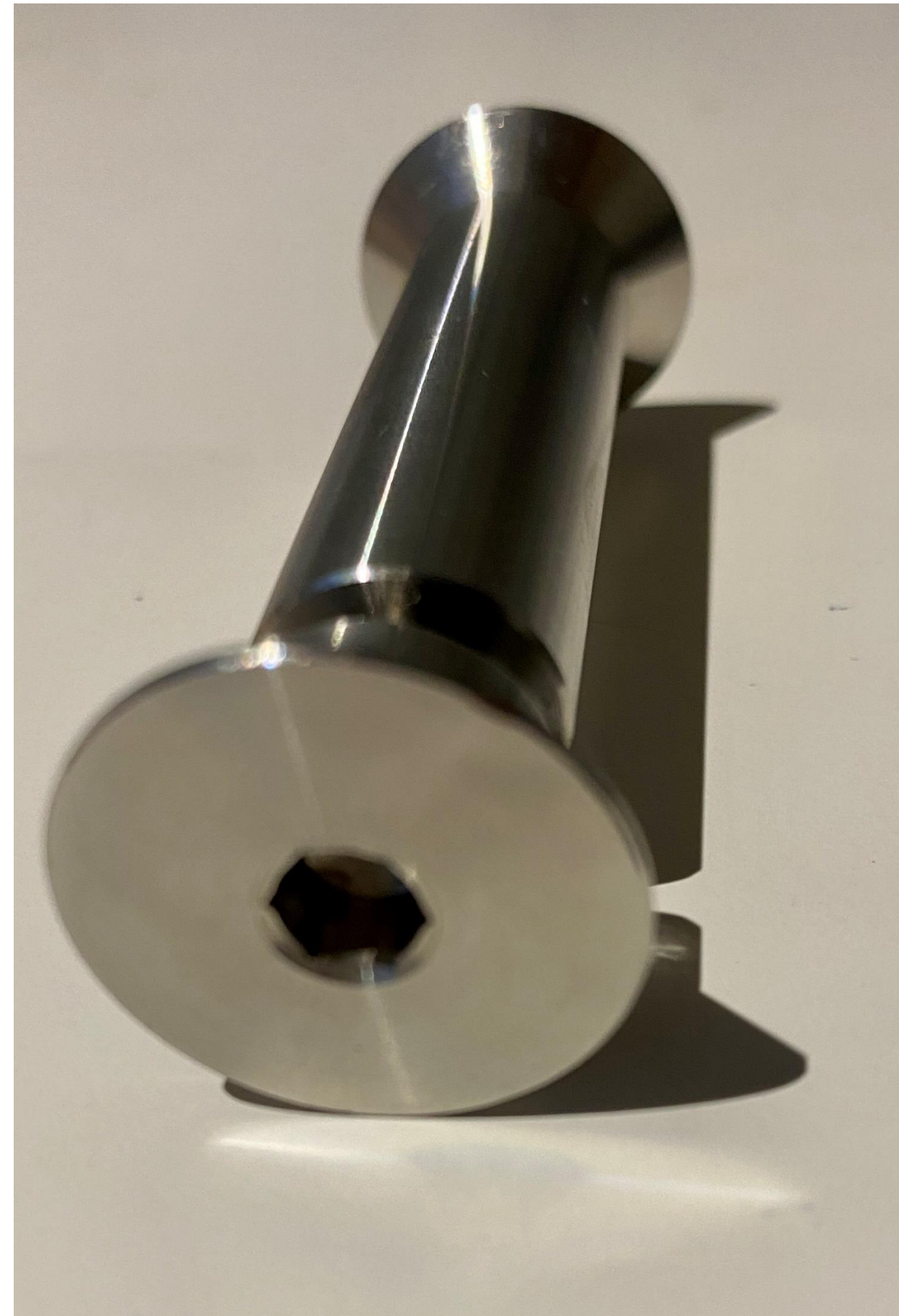

BARICHELLO
ARCHITECTURAL



MiCo Milan Convention Centre

- Milan, Italy

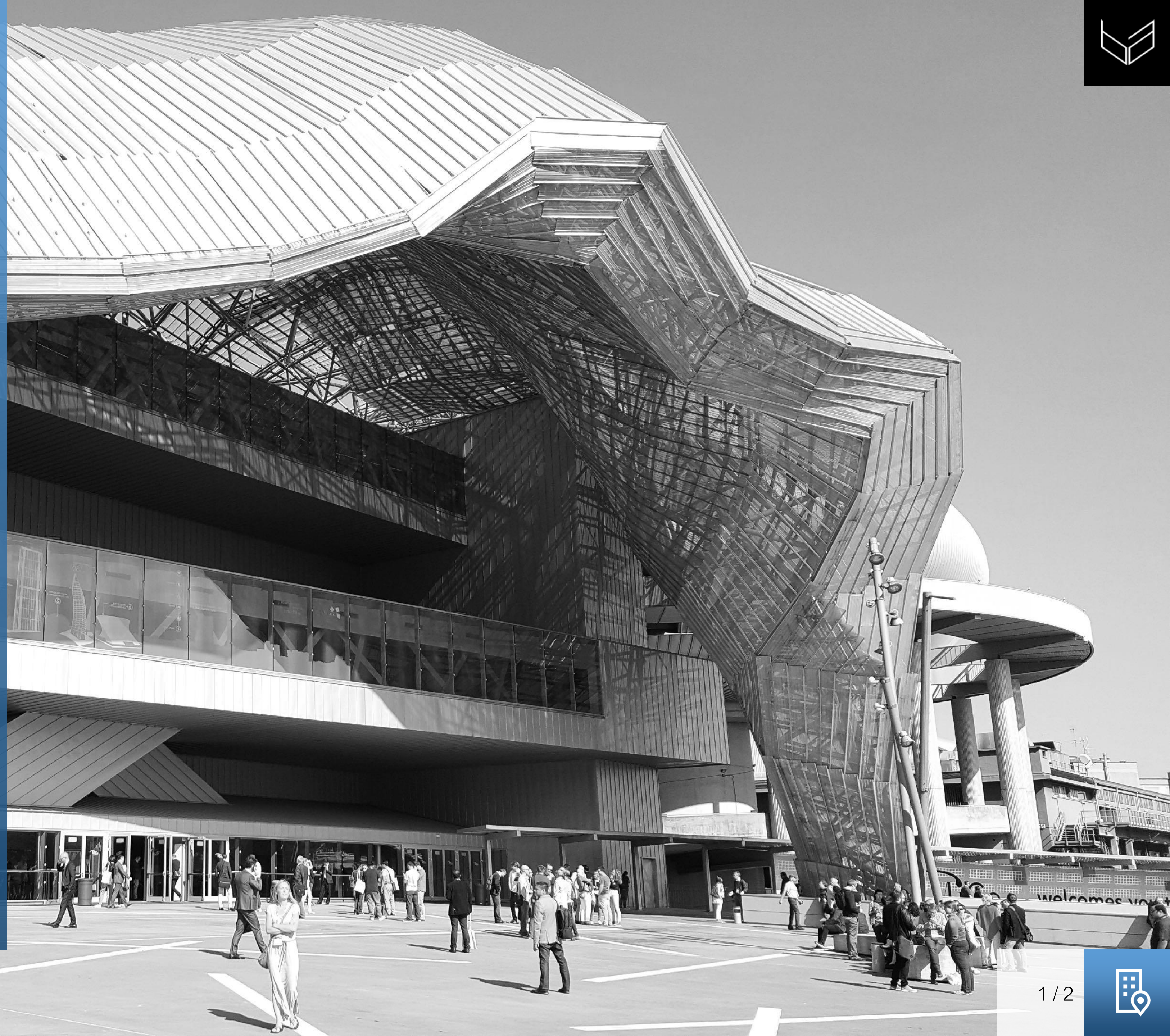

MiCo Milan Convention Centre

Milan, Italy



Budget



Size



Duration



Project Detail

Project, production,
installation of hot deep
galvanized geodesic
structure



Architects

Mario Bellini - Milan

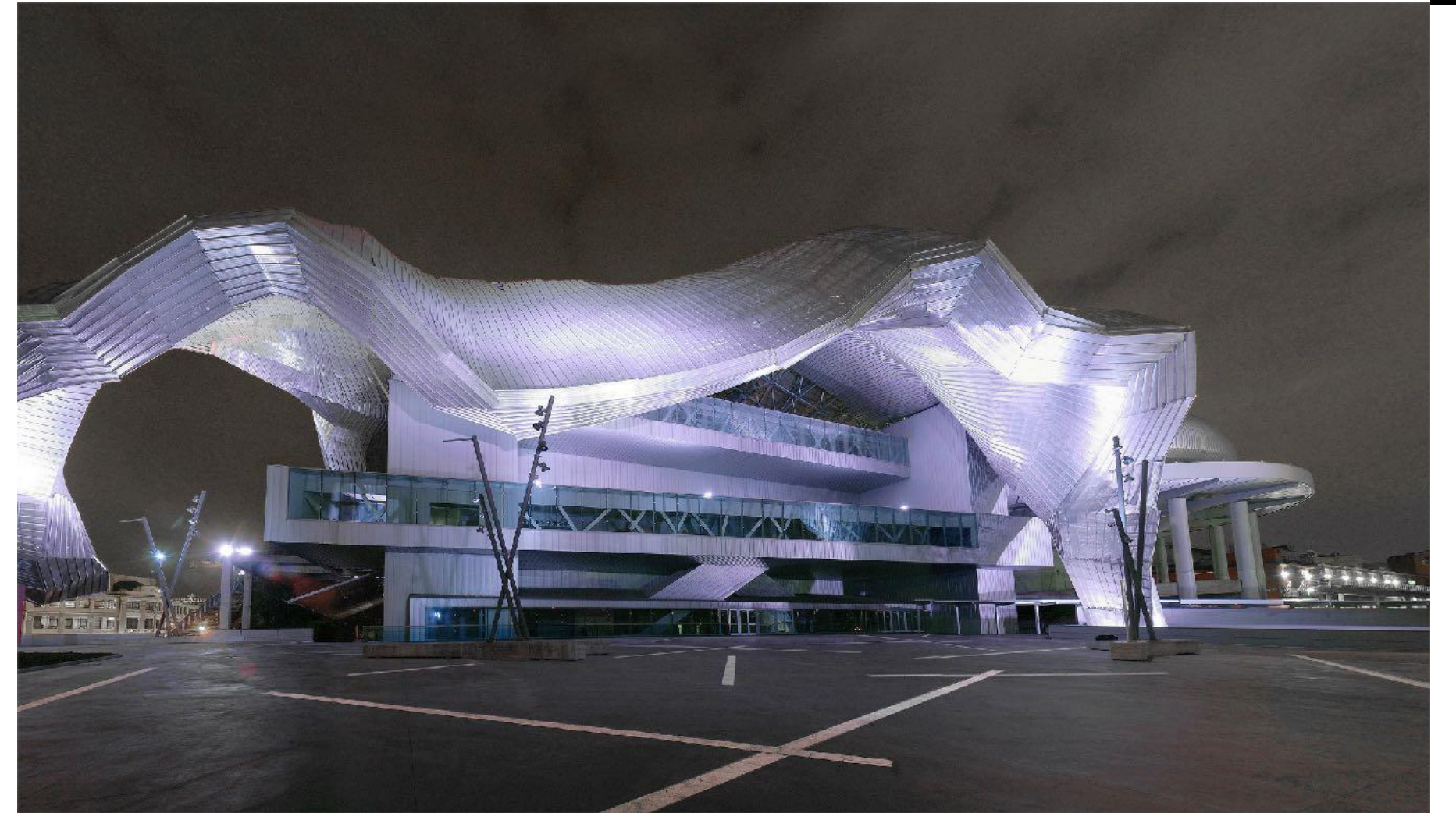
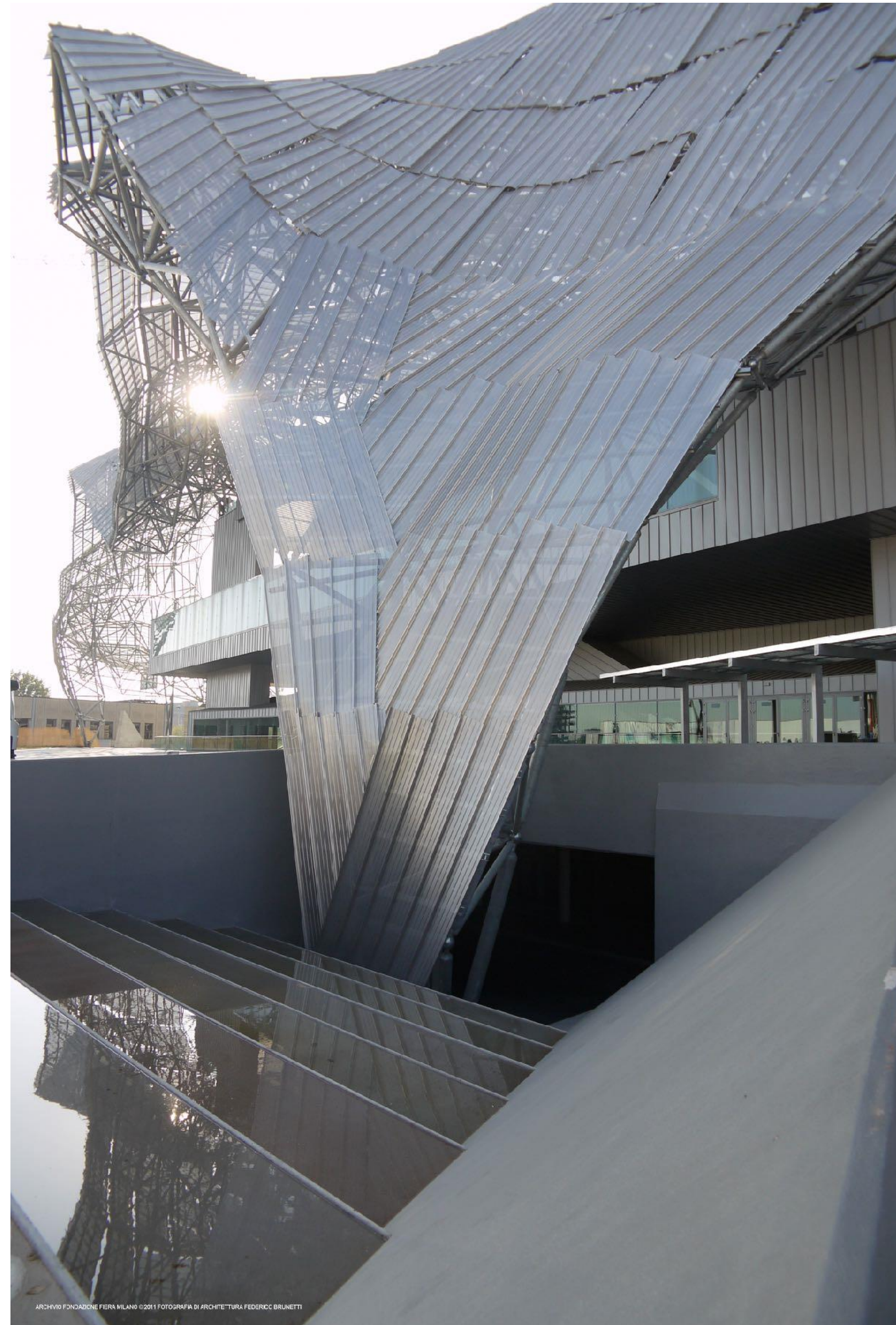

BARICHELLO
ARCHITECTURAL



San Raffaele Hospital

- Milan, Italy



San Raffaele Hospital

Milan, Italy



Budget



Size



Duration



Project details

Project, production, installation of
aluminum geodesic structure
Spiders and routels stainless steel
facades components



Architects

Mario Cucinella Architects - Bologna

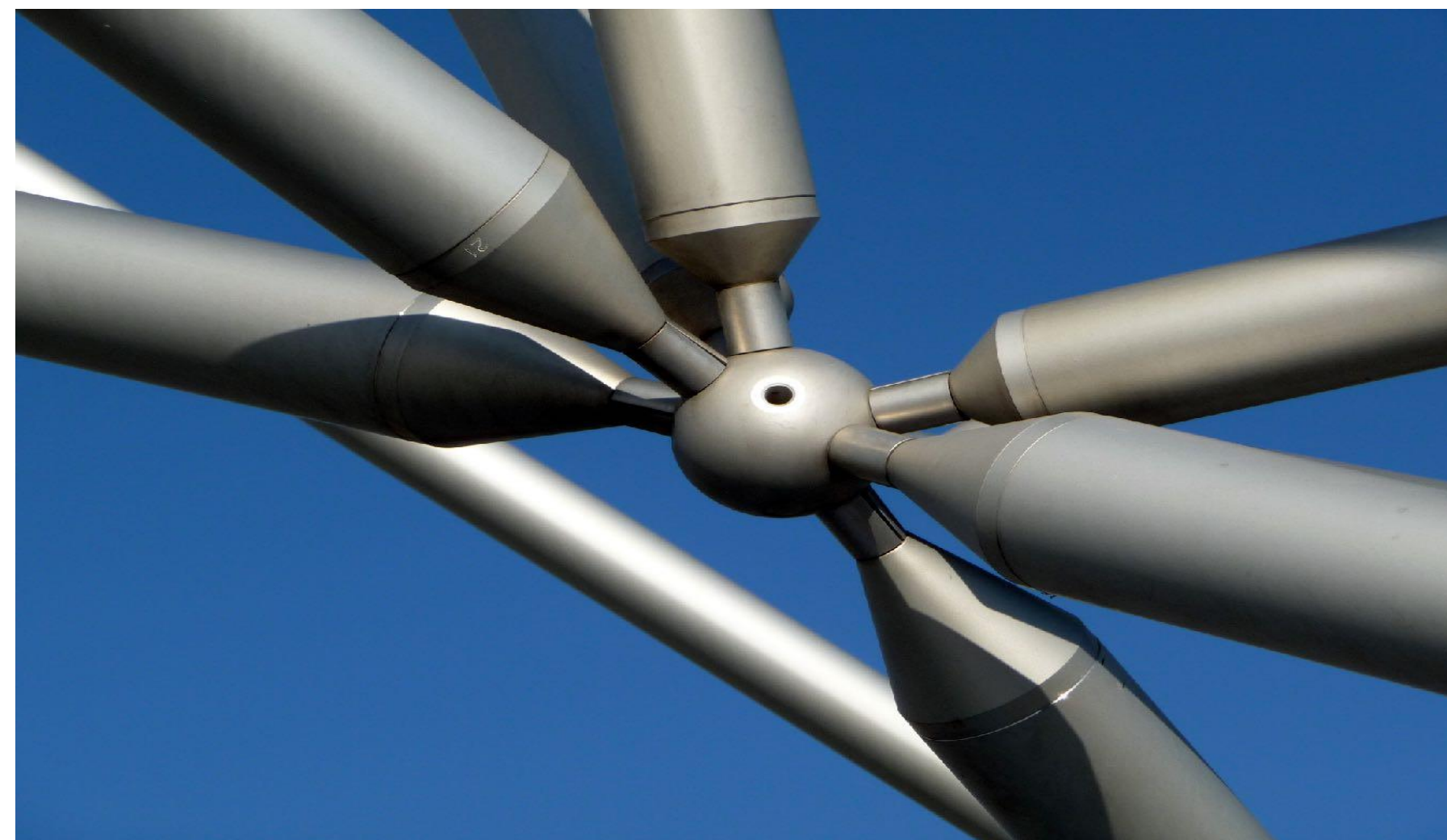

People Mover

Doha, Qatar



Architects
Grimshaw



Watermark LLC27-19

New York, USA



Architects
Rodman Paul

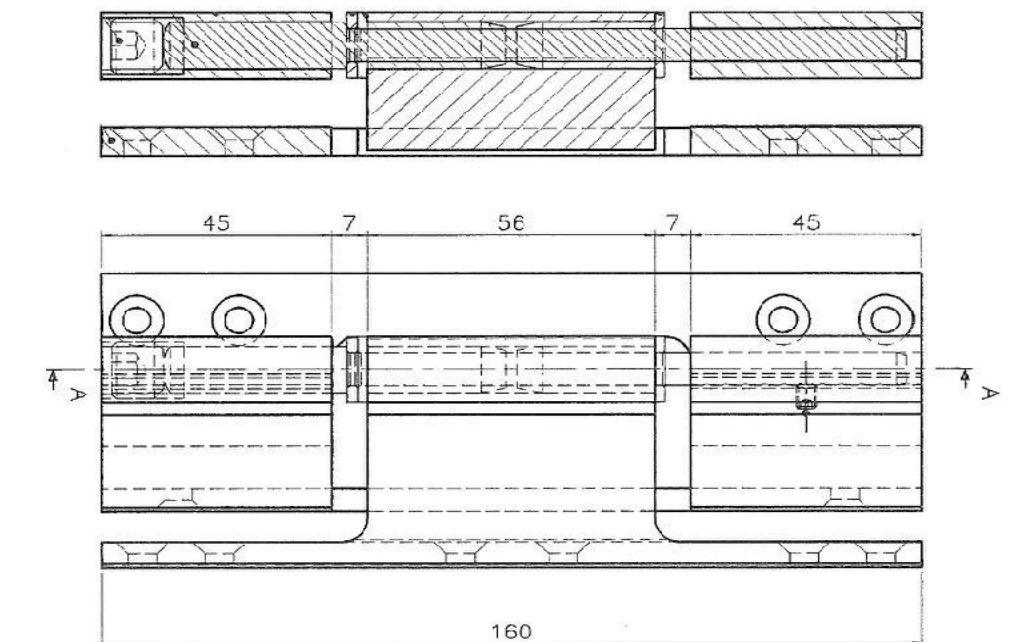
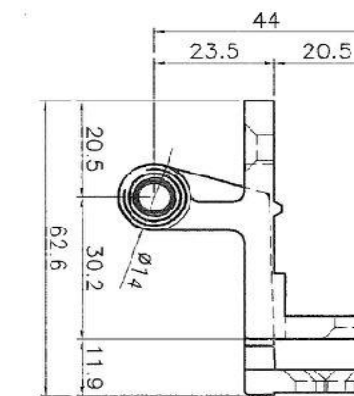

BARICHELLO
ARCHITECTURAL



Torre Isozaki Milano City Life

Milan, Italy



Architects
Zaha Hadid



One Bishopgate Plaza London

London, UK



Architects
Rick & Riba

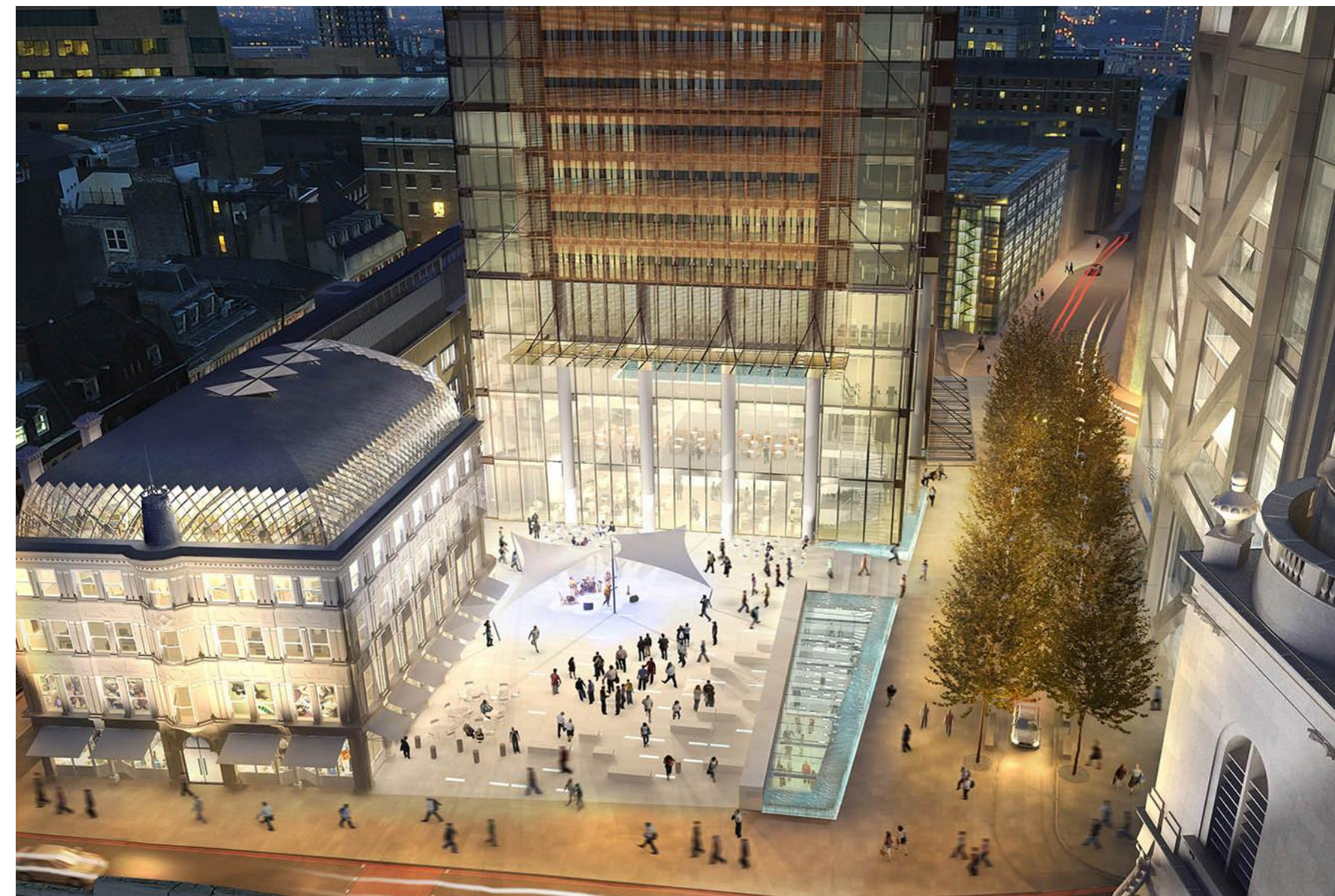

BARICHELLO
ARCHITECTURAL



11-15 Grosvenor Crescent

London, UK



Architects
Flanagan Laurence



Capital Market Authority

Riyadh, KSA



Architects
HOK - San Francisco





BARICHELO
ARCHITECTURAL

TEAM OF FIRMS

Loves *your* Architectural Project





Thank you

TELEFONO: +39 049 88 02 696

EMAIL: giorgia@barichelloarchitectural.com



BARICHELLO
ARCHITECTURAL

